

## OpenAir® GRD Series Electronic Damper Actuator

### UL Listed Fire/Smoke and Smoke Control Dampers

2-Position, 30-second Run Time,

15-second Spring Return Time



### Description

The OpenAir direct coupled, fast-acting, two-position, spring return electronic actuators are available as 24 Vac/dc, 120 Vac, and 230 Vac models. They are intended for use on UL-listed smoke control dampers and combination fire/smoke rated dampers.

### Features

- Optional built-in auxiliary switches: Fixed switch points at 5° and 85° rotation.
- Optional built-in Electronic Fusible Link (EFL) capability with four temperature ratings: 165°F (74°C), 212°F (100°C), 250°F (121°C), and 350°F (177°C).
- Reversible fail-safe spring return.
- High temperature polymer housing.
- Pre-cabled, insulated lead wires.
- Thirty-second powered operation at rated torque, temperature and voltage.
- Fifteen-second mechanical fail-safe at rated torque and temperature.



### Application

This actuator is used for the control of dampers requiring up to 30 lb-in (3.4 Nm) driving torque. It is intended for control of UL-listed smoke control dampers and combination fire/smoke HVAC dampers. This actuator is designed to meet the 2002 revisions to the UL 555/555S and the AMCA Standard 520 specifications.

## Product Numbers

Product Number*	Torque	Voltage			Control Signal	EFL Capability	3-ft Plenum Cable	Auxiliary Switch
	30 lb-in (3.4 Nm)	24 Vac/dc	120 Vac	230 Vac	2-Position			
GRD121.1U	●	●	—	—	●	●	●	—
GRD126.1U	●	●	—	—	●	●	●	●
GRD221.1U	●	—	●	—	●	●	●	—
GRD226.1U	●	—	●	—	●	●	●	●
GRD321.1U	●	—	—	●	●	●	●	—
GRD326.1U	●	—	—	●	●	●	●	●

## Warning/Caution Notations

<b>WARNING</b>		Personal injury or loss of life may occur if you do not perform a procedure as specified.
<b>CAUTION:</b>		Equipment damage may occur if you do not perform a procedure as specified.

## Service



### WARNING:

Do not open the actuator. Personal injury may occur if opened. Opening the actuator voids the warranty.

If the actuator is inoperative, replace the unit.

<b>Specifications</b>	Operating voltage	24 Vac ±20% 24 Vdc +20%, -10%
	<b>Power supply</b>	Frequency
	Frequency	50/60 Hz 120 Vac ±10%
	Frequency	60 Hz 230 Vac ±10%
	Power Consumption:	<b>Running</b> <b>Holding</b>
	GRD12x.1U	~14 VA/8W                      ~4VA/2W
	GRD22x.1U:	~12 VA                              ~4VA
	GRD32x.1U:	~12 VA                              ~4 VA
 <b>CAUTION:</b> Continuous use at voltages above the recommended tolerances may damage the actuator.		
<b>Function</b>	Running torque	30 lb-in (3.4 Nm) (minimum)
	Stall torque (minimum)	80 lb-in (9 Nm)
	Powered runtime for 90°	30 seconds nominal
	Fail-safe closing (on power loss) with spring return	15 seconds maximum
	Nominal angle of rotation	95°
<b>Life Expectancy</b>		Minimum 20,000 full stroke cycles
<b>Mounting</b>	Damper shaft size	0.5-inch (12,7 mm) round
	Damper shaft length, minimum	1.4-inch (36 mm)
<b>Housing</b>	Enclosure	NEMA 1/IP40
	Material	High temperature polymer
<b>Ambient conditions</b>	Operation	0°F to 140°F (-18°C to 60°C) one time 350°F (177°C) ½ hour per UL555S
	Storage and transport	-40°F to 158°F (-40°C to 70°C)
	Ambient humidity (non-condensing)	Maximum 95% rh non-condensing
	Teflon® cable	400°F (200°C)
<b>Fixed Dual End Switches</b>	Fixed Dual End Switches	
	AC rating	24 Vac to 250 Vac, 24 Vdc 6A resistive/ 2 FLA/12 LRA
	Temperature rating	350°F (177°C)
<b>Agency certification</b>		UL60730 cUL CSA 60730 CE Conformity for residential, commercial, and industrial environments Australian RCM conformity
<b>Miscellaneous</b>	Pre-cabled connection	
	Length:	3 ft (0.9m) 19/30 strand 18 GA
	Dimensions	8.5-in H × 3.5-in W × 3-in D (215.9 mm H × 88.9 W mm × 76.2 D mm)
	Weight	≈4 lb (1.8 kg)
	Country of Origin	USA

---

## Accessories

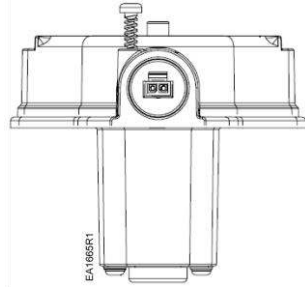

### Electronic Fusible Link (EFL)

ASK791.165 (165°F [74°C] operation)  
ASK791.212 (212°F [100°C] operation)  
ASK791.250 (250°F [121°C] operation)  
ASK791.350 (350°F [177°C] operation)

**NOTE:** Determine and order appropriate actuator before selecting EFL.

**Figure 1. Electronic Fusible Link.**

---

## Operation

When power is applied, the actuator coupling moves toward the open position, 90°. The actuator opens in **30** seconds nominal, 90° at 60 Hz. In the event of a power failure or when operating voltage is turned off, the actuator returns to the **0** position. The return time is 15 seconds nominal for 90°.

The National Fire Protection Association NFPA 92A Standard for Recommended Practice for Smoke-Control System and UL 864 Standard for Control Units and Accessories for Fire Alarm Systems, require weekly self-tests for **dedicated** smoke control equipment used in a smoke control system. The National Fire Protection Association NFPA 72 Standard for National Fire Alarm Codes states that all life-safety systems are to be functionally checked at least annually.

The GRD actuator does not require any periodic cycling to function properly as an integral part of an active smoke control damper system. Check the smoke control damper/actuator every time you functionally check your smoke detectors, emergency lights, and/or power generators for operation.

---

## Installation

See *OpenAir® GRD Series Electronic Damper Actuator Designed for UL Listed Fire/Smoke and Smoke Control Dampers Installation Instructions (A6V11416635)* for detailed guidelines.



### CAUTION:

Read and carefully follow the Installation Instructions to avoid equipment damage.

**Wiring**

All wiring must conform to NEC and local codes and regulations.

**Wire Designations**

24 Vac/dc

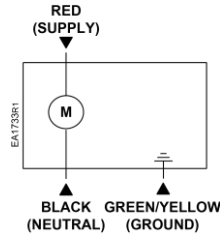

Function	Color
Supply	Red
Neutral	Black
Ground	Green/Yellow

**Figure 2.**

120 Vac

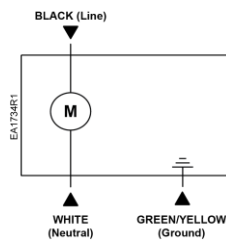

Function	Color
Line	Black
Neutral	White
Ground	Green/Yellow

**Figure 3.**

230 Vac

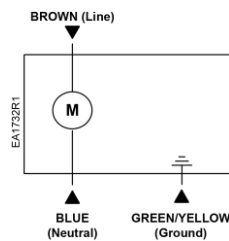

Function	Color
Line	Brown
Neutral	Blue
Ground	Green/Yellow



**CAUTION:**

The actuator must be wired with a 230 Vac line with respect to neutral and the ground lead must be connected for proper protection of the actuator. Any other connection, such as phase-to-phase, can damage the actuator.

**Figure 4.**

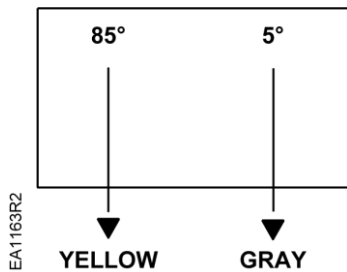

Switch	Wire Color	Switch Makes	Switch Breaks
5°	Gray	< 5°	> 5°
85°	Yellow	> 85°	< 85°

**Figure 5. Fixed Dual End Switches.**

**NOTE:**

Both sets of contacts are open when actuator is between 5° and 85°.



**CAUTION:**

Mixed switch operation to the switching outputs of both dual end switches (5° and 85°) is not permitted.

Either AC line voltage from the same phase must be applied to all four outputs of the fixed dual end switches, or UL-Class 2 voltage must be applied to all four outputs.

## Wiring, Continued

**NOTE:**

If you are not using an EFL, do not modify the actuator. An EFL or jumper must be installed for actuator to work properly.

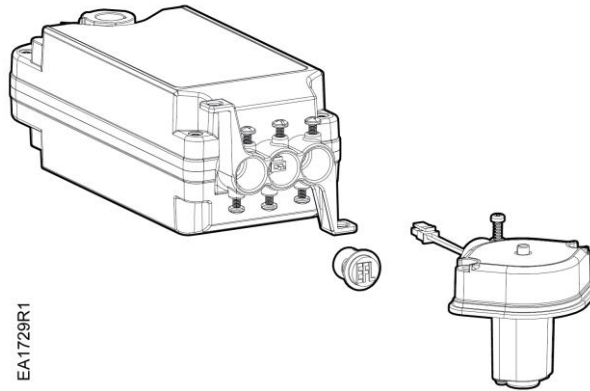

Figure 6.

## Dimensions

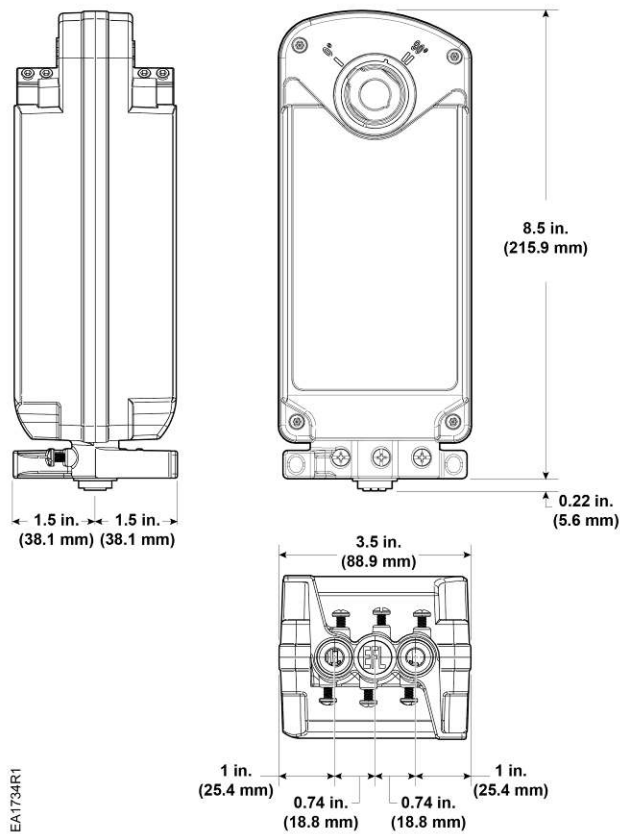

Figure 7. Dimensions of the OpenAir GRD Actuator in Inches (Millimeters).

Information in this publication is based on current specifications. The company reserves the right to make changes in specifications and models as design improvements are introduced. OpenAir is a registered trademark of Siemens Schweiz AG. Other product or company names mentioned herein may be the trademarks of their respective owners. © 2019 Siemens Industry, Inc.